



Exhaust Systems Engine Mounts Carb Air Boxes

Shrouds • Seats • Piston • Turbine • Radial • Vintage • And More...



CESSNA 175 LYC O360 CONVERSION (STC: SA777CE)

Item	Part Number	Description
1	15006	AVCON MUFFLER
2	AVCONRISERL/R	RISER LEFT REAR
3	AVCONRISERL/F	RISER LEFT FRONT
4	AVCONRISERR/F	RISER RIGHT FRONT
5	AVCONRISERR/R	RISER RIGHT REAR
6	600-00A	AVCON MUFFLER SHROUD
NS	77611	GASKET

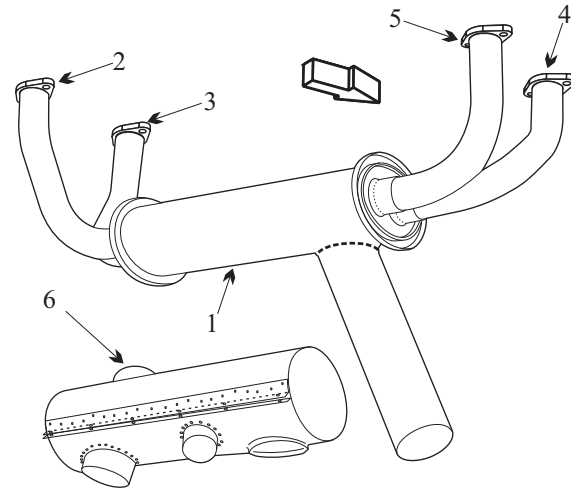

AD 74-06-02
Applies to STC Avcon Industries muffler.
Replace muffler.

- The muffler must have inner flame tubes still attached to be serviceable.
- Riser slip joints into muffler should move freely to avoid stress on muffler end plates and allow for service and inspection. The riser stack ends tend to flare out inside the muffler and seize, preventing removal of the risers. It would be wise to check if stacks can be removed from the muffler before ordering just the muffler.

(toll free) 1-888-388-8803 1-780-447-5955 Fax: 1-780-447-5980
sales@acornwelding.com parts@acornwelding.com www.acornwelding.com